



Each Aquamate comes complete with a wand valve, multiple spray heads, two watering tubes, utility bag, service tray and a maintenance kit.

Item Number	Description	Suggested List Price Each
AQM2	Model 2 - 9 gallon capacity	\$ 897.00
AQM3	Model 3 - 12 gallon capacity	\$ 1070.00
AQM4	Model 4 - 20 gallon capacity	\$ 1355.00
AQM 5	Model 5 - 28 gallon capacity	\$ 1610.00
AQM6	Model 6 - 40 gallon capacity	\$ 1822.00

A complete listing of accessories and replacement parts is available.



CWVB

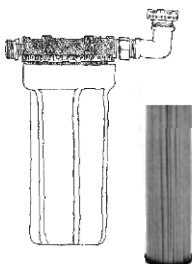
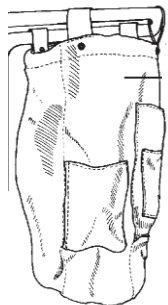
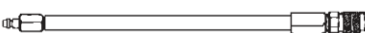
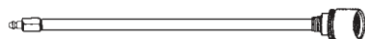
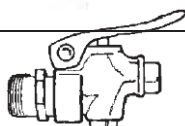

PART NUMBER	DESCRIPTION	PRICE
<b>WAND VALVES</b>		
BLKSP	Premium wand valve	\$ 36.55
CWV	Chrome plated wand valve w/socket	36.55
	Chrome plated wand valve body only	20.45
<b>WAND TUBES - with Bubbler heads attached</b>		
SWT12	Standard 45° Wand Tube - 12"	23.75
SWT24	Standard 45° Wand Tube - 24"	27.25
SWT36	Standard 45° Wand Tube - 36"	30.80
SWT48	Standard 45° Wand Tube - 48"	34.25
SWT60	Standard 45° Wand Tube - 60"	37.70
BWT12	Basket 120° Wand Tube - 12"	23.75
BWT24	Basket 120° Wand Tube - 24"	27.25
BWT36	Basket 120° Wand Tube - 36"	30.80
BWT48	Basket 120° Wand Tube - 48"	34.25
BWT60	Basket 120° Wand Tube - 60"	37.70
STRWT24	Straight Wand Tube - 24"	27.25
EXT24	Wand Tube Extension - 24"	27.25
EXT36	Wand Tube Extension - 36"	30.80
EXT48	Wand Tube Extension - 48"	34.25
EXT60	Wand Tube Extension - 60"	37.70
CWV12SWT	Chrome Wand Valve w/ fixed 12" std wand tube	61.40
CWV24SWT	Chrome Wand Valve w/ fixed 24" std wand tube	63.10
<b>UTILITY BAGS</b>		
UBSM	Green Utility Bag for AQM1-AQM3	47.15
UBLG	Green Utility Bag for AQM4-AQM6	56.00
<b>SOLUTION INJECTORS &amp; FILTER CARTRIDGES</b>		
SI20	Solution Injector 20 oz. for AQM1-AQM3	78.75
SI40	Solution Injector 40 oz. for AQM4-AQM6	87.40
SI20C	Solution Injector 20 oz. Clear Sump for AQM1-AQM3	78.75
SI40C	Solution Injector 40 oz. Clear Sump for AQM4-AQM6	87.40
PFR30-478	Sediment filter for 20 oz. Solution Injector	30.64
PFR30	Sediment filter for 40 oz. Solution Injector	39.21
9314-077	O-ring replacement for Solution Injector	4.42
<b>HOSE EXTENSIONS - GHT to ball valve, connects to ball valve</b>		
HEX10	10' Hose extension	50.60
HEX15	15' Hose extension	59.35
HEX20	20' Hose extension	68.10
PG100	Filling Gauge	35.00

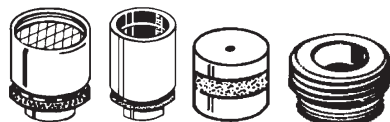
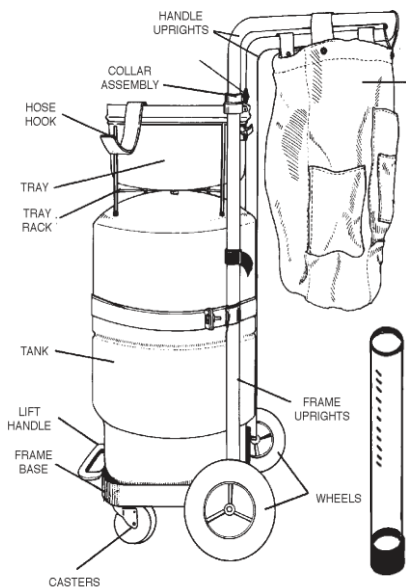

PART NUMBER	DESCRIPTION	PRICE
<b>HANDLES &amp; FRAME ASSEMBLY</b>		
HNDASM	Handle upright assembly for AQM1-AQM3	\$ 71.30
LH1	Lift Handle on frame base for AQM1-AQM3	8.05
3801 FRAME	Frame assembly for AQM1-AQM3	612.25
3804 FRAME	Frame assembly for AQM4	699.20
3805 FRAME	Frame assembly for AQM5	699.20
3806 FRAME	Frame assembly for AQM6	699.20
	(Assembly includes wheels, casters, base, uprights, handles)	
3801-0092	Collar Assembly	13.75
3801-0118	Clear wand tube holder assembly for AQM4-AQM6	13.95
<b>WHEELS &amp; CASTERS - Bolt packages are also available.</b>		
WHL8	8" Wheel for AQM1-AQM3	14.95
WHL10	10" Wheel for AQM4	22.75
WHL12	12" Wheel for AQM5-AQM6	33.25
CST4	4" Caster for AQM1-AQM3	20.25
CST5	5" Caster for AQM4-AQM5	24.50
CST6	6" Caster for AQM6	33.25
LCST4	4" Locking Caster for AQM1-AQM3	22.05
LCST5	5" Locking Caster for AQM4-AQM5	26.25
HC1	Hub Cap for AQM1-AQM3	0.99
<b>TRAYS &amp; RACKS</b>		
RDTRAY	Round Tray with lid for AQM1-AQM3	18.50
SQTRAY	Square Tray with lid for AQM4-AQM6	18.50
RDRACK	Round Tray Rack for AQM1-AQM3	24.65
SQRACK	Square Tray Rack for AQM4-AQM6	31.60
<b>HOSE REPLACEMENTS - Hose barb to ball valve, connects to tank bottom</b>		
HRP12	12' Hose replacement	54.25
HRP15	15' Hose replacement	59.35
HRP18	18' Hose replacement	64.65
<b>NOZZLES</b>		
NK5	Nozzle Package includes one each: Bubbler Head, Spray Head, Mist Head, Threaded Faucet Adapter and Slip-on Faucet Adapter	26.35
BUBHD	Bubbler Head	6.50
SPRHD	Spray Head	6.50
MSTHD	Mist Head	6.50
THFA	Threaded Faucet Adapter	6.50
SLFA	Slip Faucet Adapter	6.50

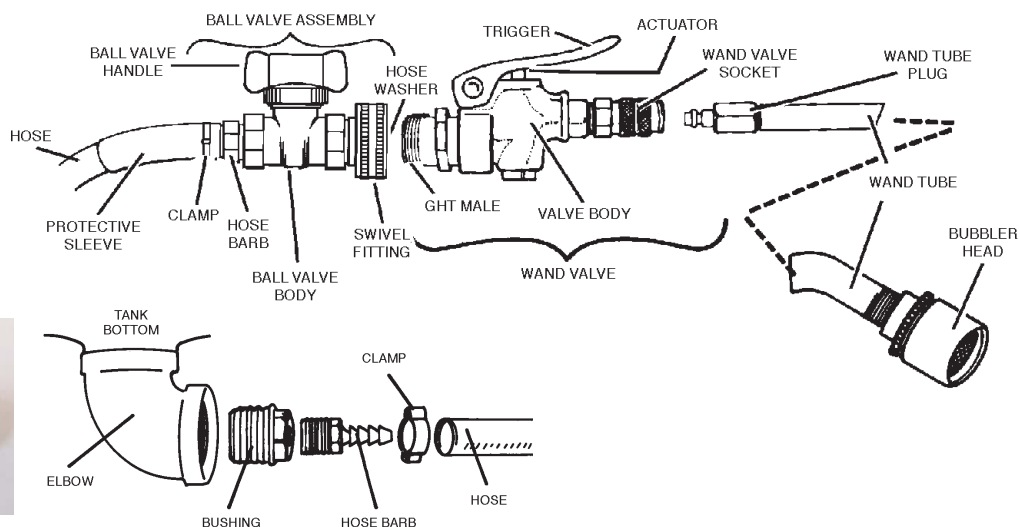

PART NUMBER	DESCRIPTION	PRICE
<b>FITTINGS - See parts identification above</b>		
BV38	Ball Valve Assembly - 3/8"	\$ 32.70
HBR1	Protective sleeve hose bend restrictor	3.75
62604	Clamp	1.85
9314-008	Hose Barb - 3/8"	4.77
SWVL	Swivel Fitting on end of ball valve	9.35
9314-012	Hose Washers, set of 10	4.70
9314-043	Wand Valve Socket	13.95
9314-039	Wand Tube Plug	5.75
CWVB-WASHER	Thin Black Hose Washer,	.62
<b>HOOKS</b>		
HHK	Hose Hook	11.10
WTHK	Wand Tube Hook	7.60
<b>ADDITIONAL ACCESSORIES</b>		
HVB75	Vacuum Breaker to prevent backflow, 3/4"	15.54
MAINT KIT	Maintenance Kit - Includes: touch-up paint, 2 clamps, 10 washers, teflon tape.	10.65
TANK KIT	New Tank Kit - Includes: Wand valve, spray head, mist head, threaded faucet adapter, hose and wand hooks, plus the maintenance kit components listed above.	70.45
41RK	Chrome wand valve actuator w/ o-rings	5.18
SP GREEN	Spray Paint, Green matched acrylic enamel, 12 oz.	22.95
SP GRAY	Spray Paint, Gray matched acrylic enamel, 12 oz.	22.95